

I Lucci Argentati, school of *light*.

design Dodo Arslan
terzani.com





Name
I Lucci Argentati
large linear chandelier

Materials
metal



Finishes | Code

-  white
ON81S M2 C8 L
-  brushed nickel plated
ON81S H4 C8 L
-  brushed gold plated
ON81S L9 C8 L

Body

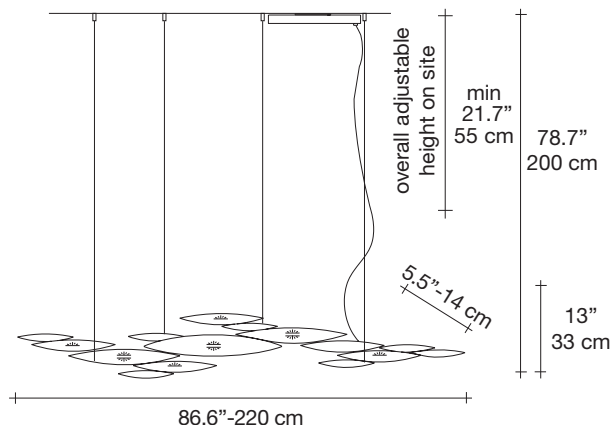

Light source

120V ~ 50/60Hz

 Built in Replaceable LED Module
10 x 4.5W 6617 lm CRI 90 3000K
or optional 6000 lm 2700K



dimmmable options

-  1-10V
PWM
10-100kΩ

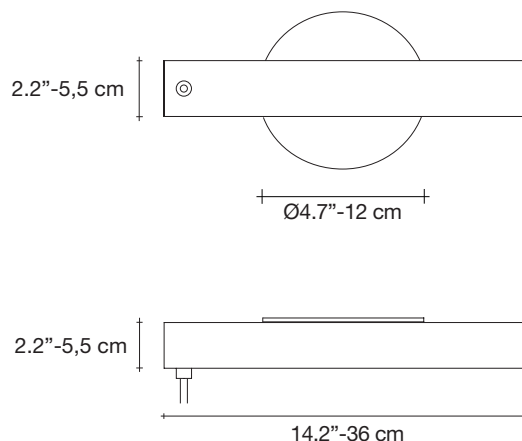
Canopy



I Lucci Argentati draws from nature to create a whimsical, yet modern light. Recalling a school of fish darting through freshwater, it creates a mesmerizing luminescence. Sets of sleek elements combine to form a stunning pendant with thin incisions along the bottom creating an understated, tranquil beauty. Thanks to its modular system, I Lucci Argentati is customizable and can be combined in many different configurations: from small to extra large; as a pendant or sconce; and finished either in brushed nickel, brushed gold or white. Design Dodo Arslan. Made in Italy

-  19.8 lbs
9 kg
-  39.7 lbs
18 kg
-  94.9" x 18.1" x 8.7"
241 x 46 x 22 cm